

ESJTM

ENERGY SAVER

Double Layer Wall Install Instructions

FOR NEW CONSTRUCTION

Read the entire instructions before you begin.

Before you begin:

Locate the shipping pallet that contains the Energy Saver system installation packet, which will be indicated by a marked sticker.

It will contain:

- *Jobsite Cutlist* - This should be used to inventory all Energy Saver fabric/components and unfaced insulation rolls. Additionally, it will indicate where the products are to be installed on your project.
- *Installation Instructions* - These will be used to explain the steps involved with the Energy Saver wall installation.
- *Packing Slip(s)* - This is the carrier's paperwork detailing delivered materials. Please be sure to inventory all materials and mark any shortages before signing delivery paperwork.

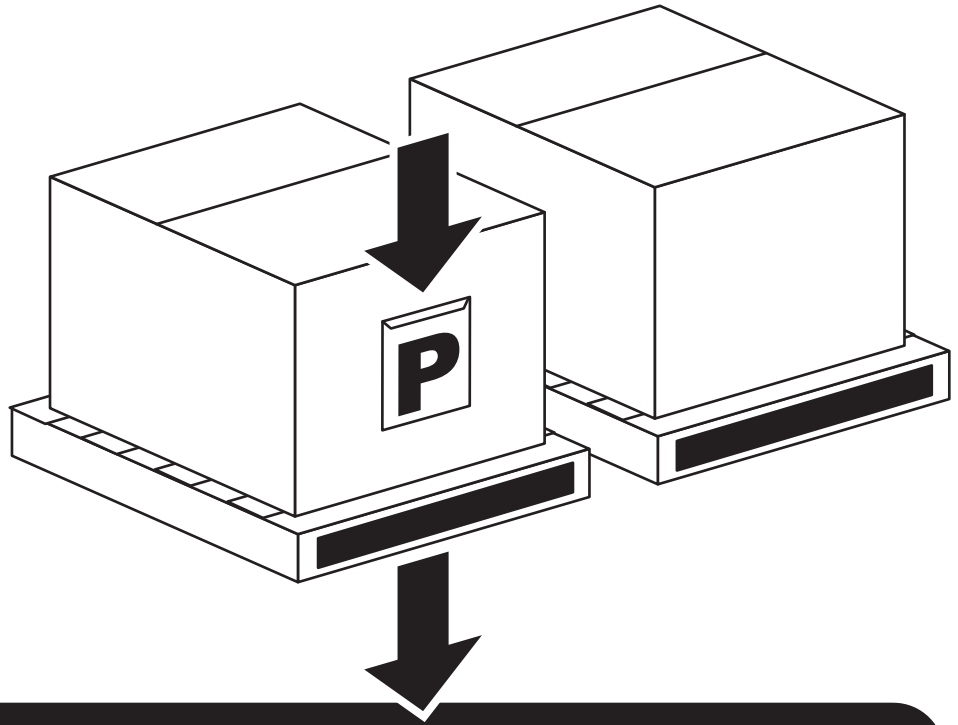

The pallet(s) will also contain the accessories needed for the successful completion of your Energy Saver Wall:

Energy Saver Fabric (bagged and labeled with size and installation locations)

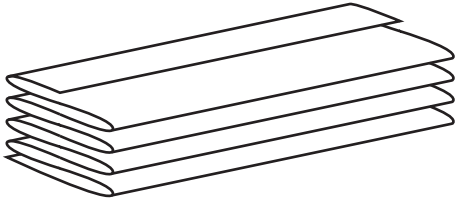

3/4" metal tek screws with washer



Patch tape

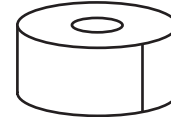

Energy Saver banding dispenser

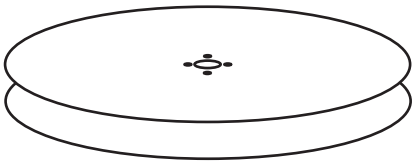

Energy Saver double sided tape



Energy Saver banding

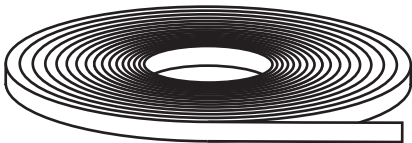

Insul-hold

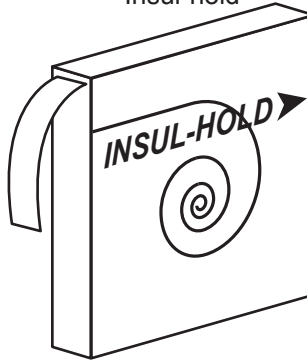

Energy Saver thermal foam tape

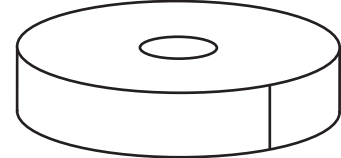

! The Energy Saver system is not recommended for high humidity applications and should never be used in buildings housing pools or open sources of water.

What an Energy Saver wall does!

Providing a clean, plum and finished appearance is only part of a correctly installed Energy Saver Wall system. Properly filling the cavity must also be done to provide optimal performance.

The **facing** is plum with wall girts

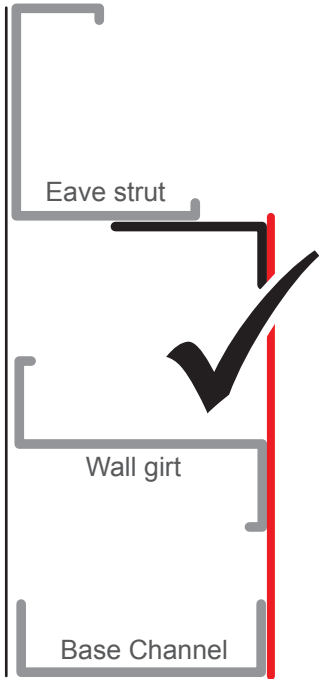

The **facing** needs additional support

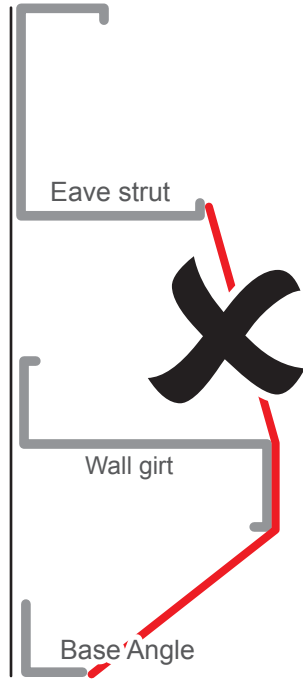

The **insulation** fills the cavity



The **insulation** is creating gaps

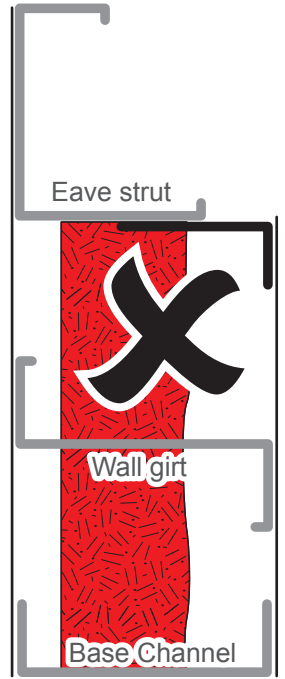

! **WARNING** - Metal angle is not provided by Silvercote.

For specific Endwall, Sidewall and Roof applications, see the list of technical details at the end of these instructions.

STEP 1. Vertical or Horizontal Insulation Install

1.1 Your Energy Saver wall was ordered for the insulation to be installed Vertically or Horizontally. Determine which you have.

Vertical insulation install - GO TO STEP

2

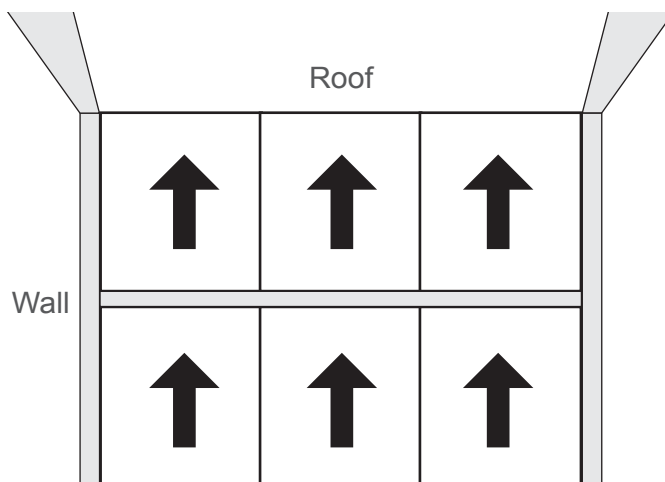

Horizontal insulation install - GO TO STEP

3

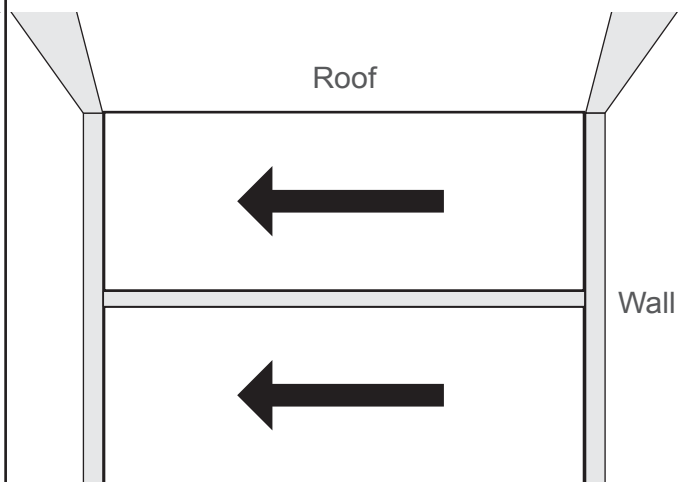

STEP 2. Vertical Insulation Install

2.1 Hang the supplied R-10 perforated foil-faced insulation to the exterior side of the wall girts. This can be accomplished by temporarily securing or clamping the unrolled insulation panels to the eave and intermediate girts of the building. Foil side should face to the exterior of the building.

2.2 Trim 6" of insulation off the bottom end and wrap the facing around to the inside.

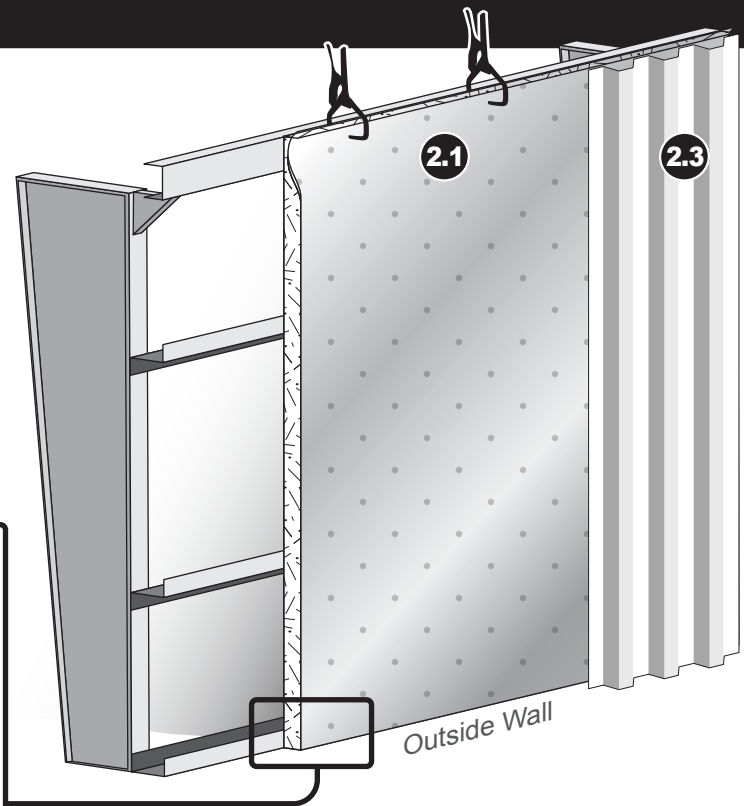
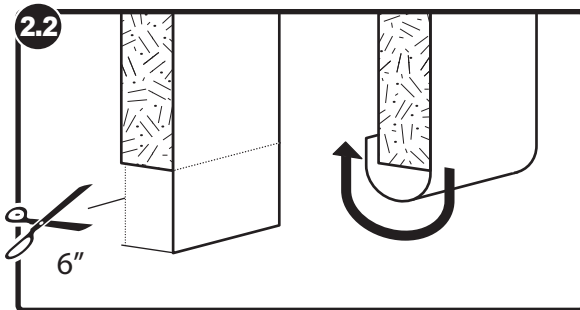

2.2 Install wall sheathing as per the manufacturer's instructions.

2.4 Cut Insul-hold to a length equaling approximately 2/3 of the height of each girt space and install by attaching to the outer flange of each girt.

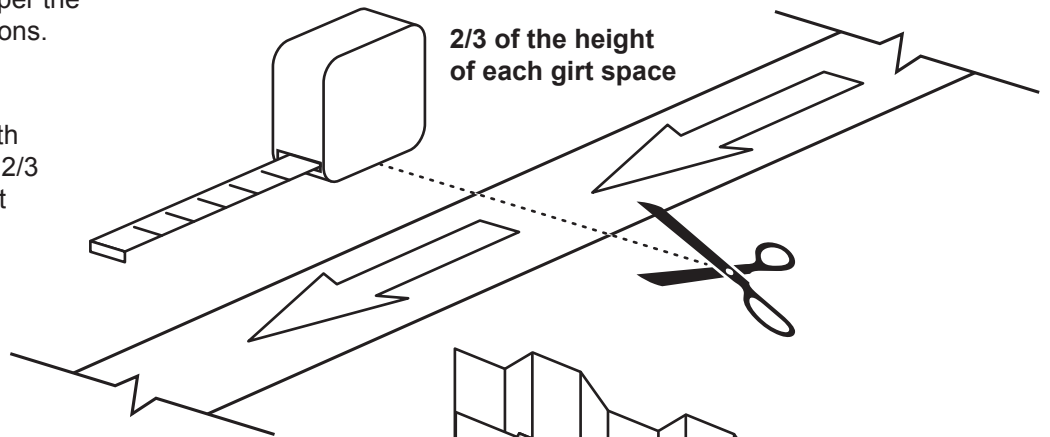

2.5 With the arrows facing up, insert the cut Insul-hold between the girt and the wall sheathing, extending 1-2" above the girt flange and bend inward to support hanger.

2.6 Insul-hold should be placed at 36"- 48" apart.

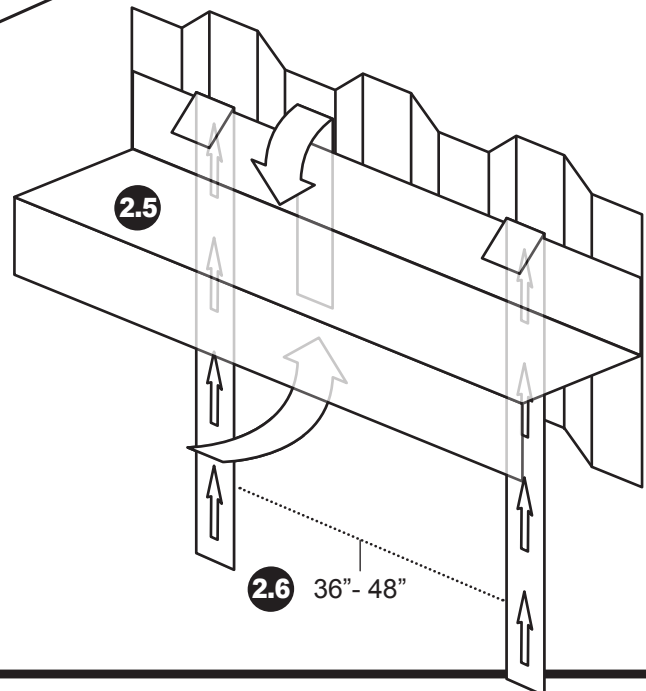

STEP 2. Vertical Insulation Install (CONTINUED)

2.7 From the inside of the building, bend arrows down to a 90 degree angle.

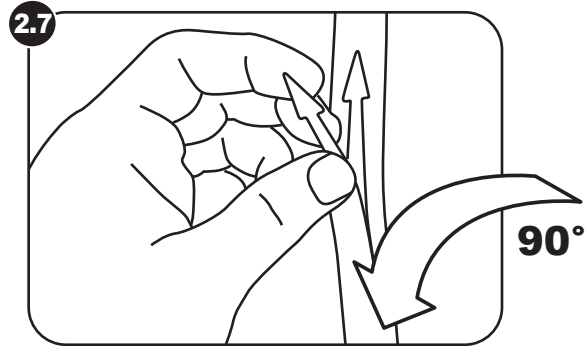

Bend arrow toward the inside of building

2.8 Cut supplied rolls of unfaced insulation to appropriate girt space size 1" longer than girt space to assure a friction fit.

2.9 Install insulation in the cavity impaling it on the Insul-hold arrows for support.

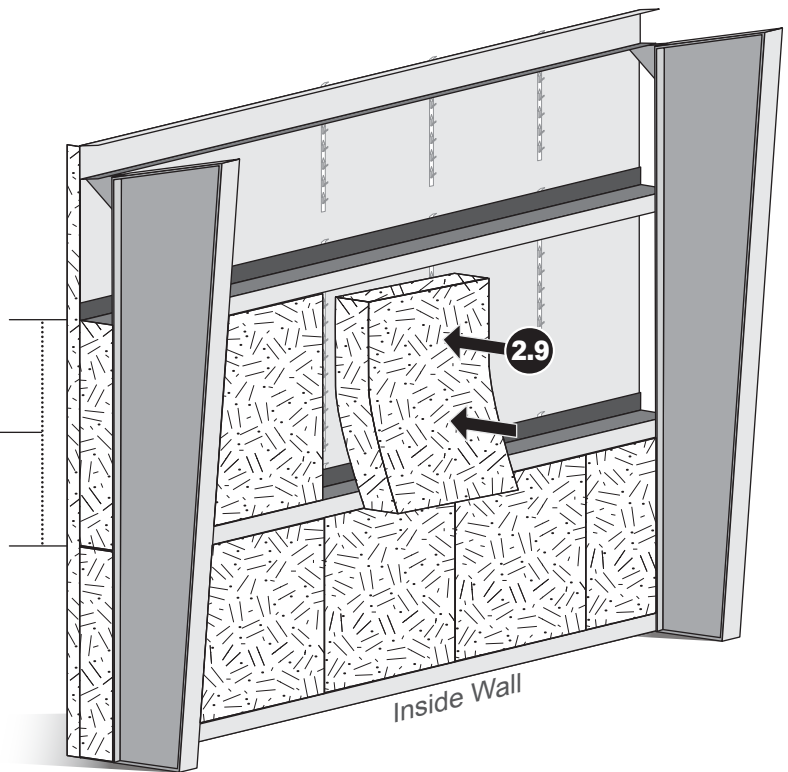
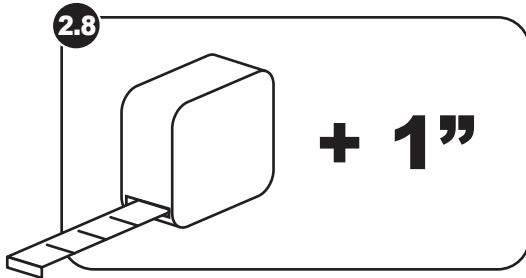

Continue to STEP 4

STEP 3. Horizontal Insulation Install

3.1 Cut Insul-hold hangers to length of the eave height of the building.

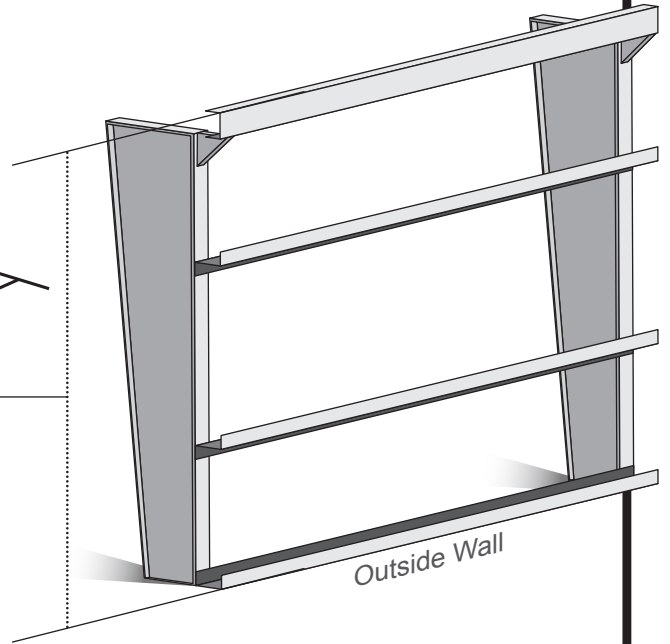
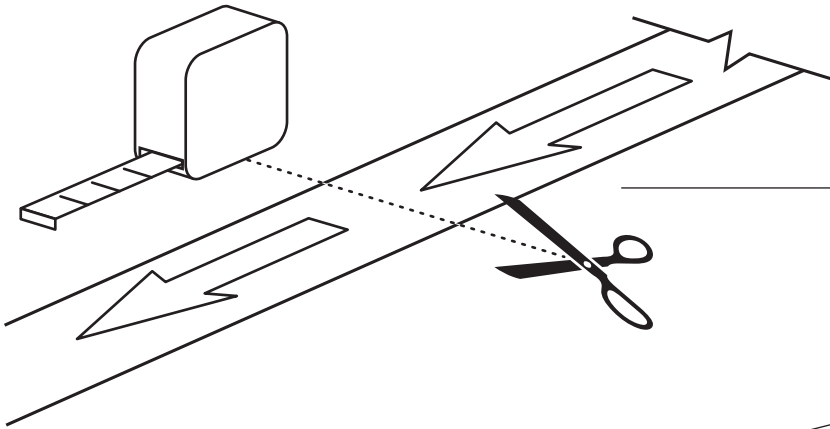

3.2 Install Insul-hold plumb and true using $\frac{3}{4}$ " tek screws with washers to the eave strut and base channel. Additional screws may be attached to girts if desired. Insul-hold should be installed full height on 5' centers.

3.2 $\frac{3}{4}$ " tek screw with washer

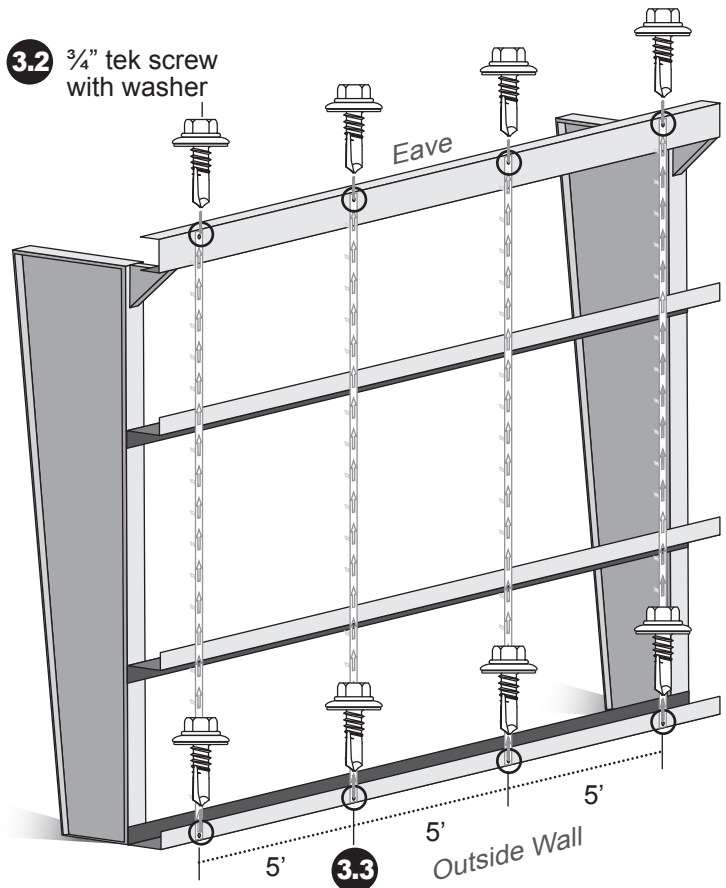

3.3 Insul-hold should be installed full height on 5' centers with the arrows pointing up.

3.4 From the inside of the building, bend arrows down to a 90 degree angle.

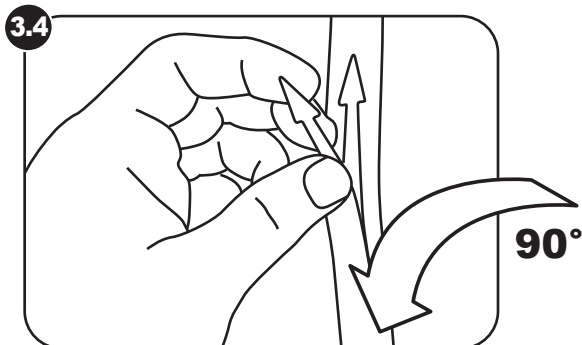

Bend arrows toward the inside of building

! WARNING - Insul-hold should support each end of insulation. Additional Insul-hold pieces may be cut and installed if needed

STEP 3. Horizontal Insulation Install (CONTINUED)

3.5 For a double layer wall only - Install supplied R-10 perforated foil-faced insulation to the exterior side of the wall girts. This can be accomplished by Temporarily securing or clamping the unrolled insulation panels to the eave and intermediate girts of the building. Foil side should face to the exterior of the building.

For framed openings see the SIL801 - Door and Window Technical Detail.

3.6 Install wall sheeting per the manufacturers instructions.

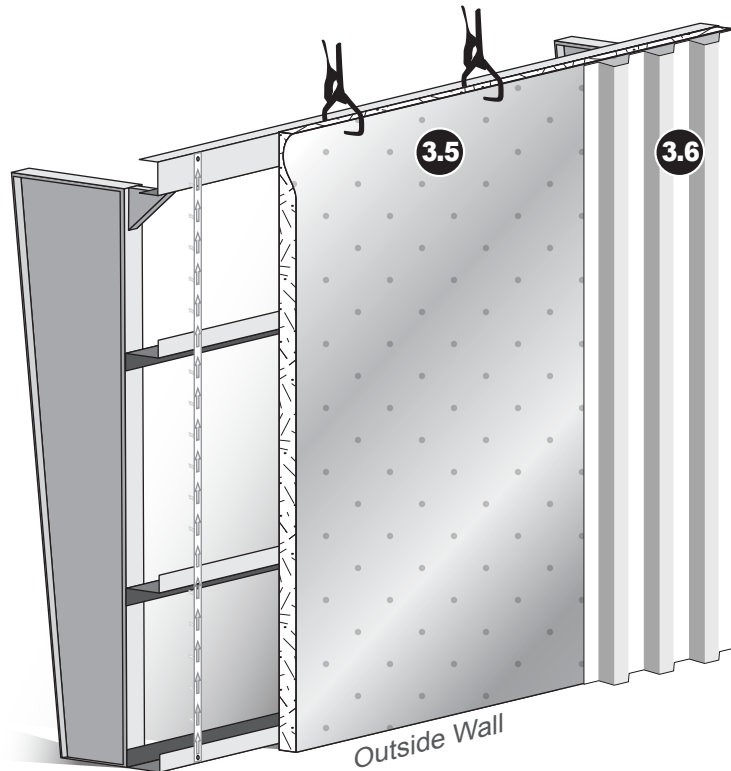

3.7 Locate the proper width of insulation for the height of each girt space. Unroll insulation, cutting to length plus 1" longer to assure a friction fit. Install cut roll into the cavity and impaling it on Insul-hold arrows.

3.8 Apply the Energy Saver double-sided tape to the metal angle at Eave Strut, along the base channel and along the sides of the main structurals.

! WARNING - Metal angle is not provided by Silvercote.

3.9 Remove the tape backing along the metal angle only.

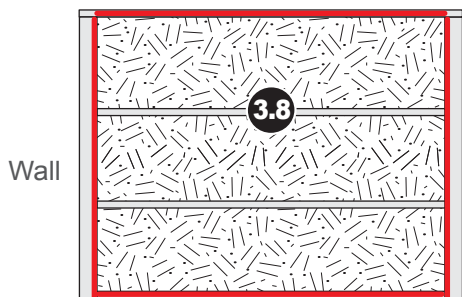
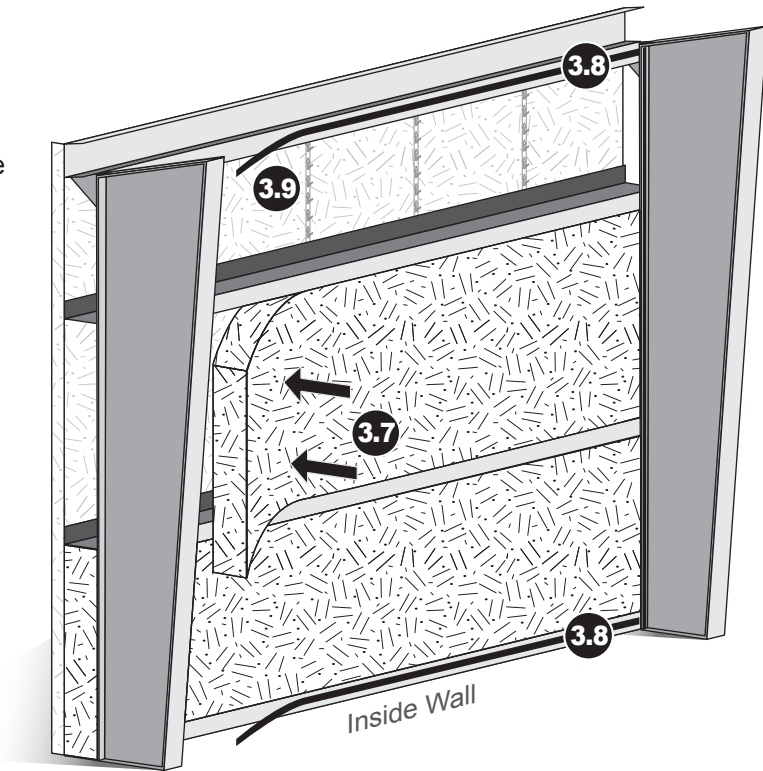

STEP 4. Install the Energy Saver wall fabric and banding

4.1 Pull the wall fabric up toward the wall girt to the metal angle. Ensuring the fabric is square, apply the fabric to the Energy Saver double-sided tape.

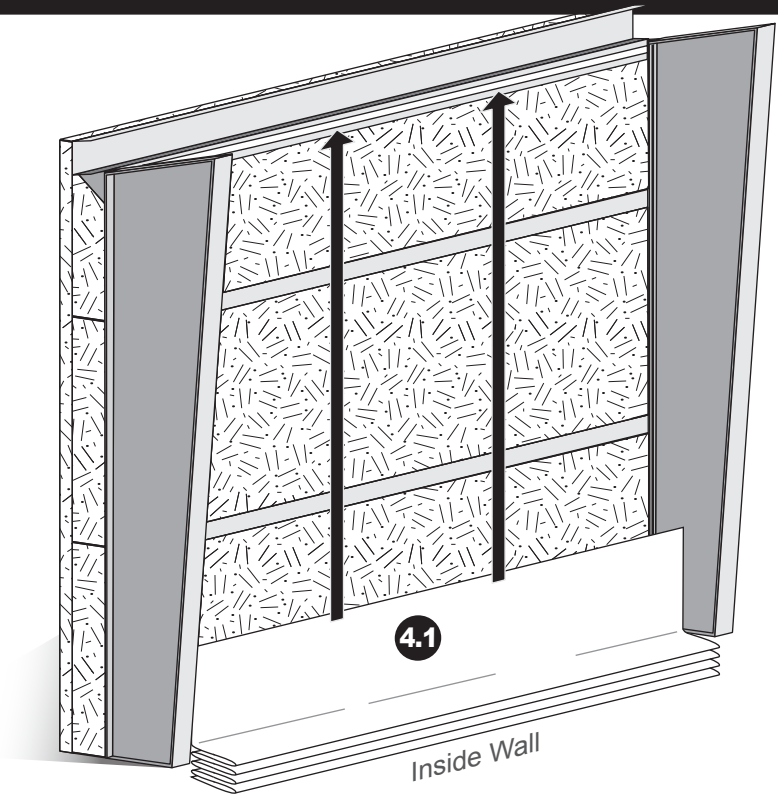

4.2 Fasten $\frac{3}{4}$ " tek screws with washers through the Energy Saver banding and fabric into the metal angle on 60" centers.

NOTE: If installing in conjunction with Energy Saver roof insulation, it is recommended that the bands be positioned in line with the cross bands of the roof system.

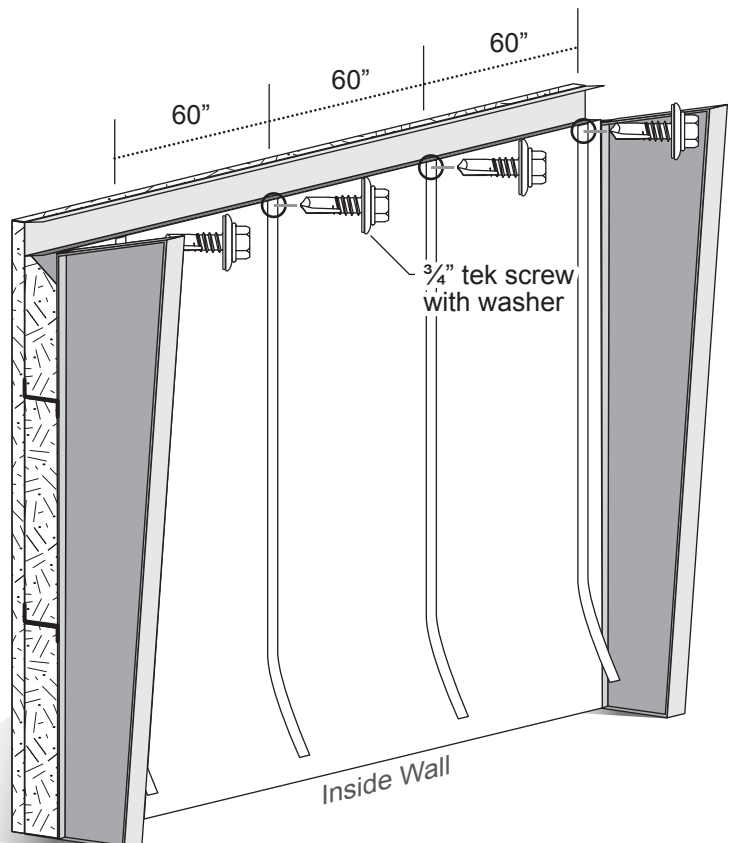
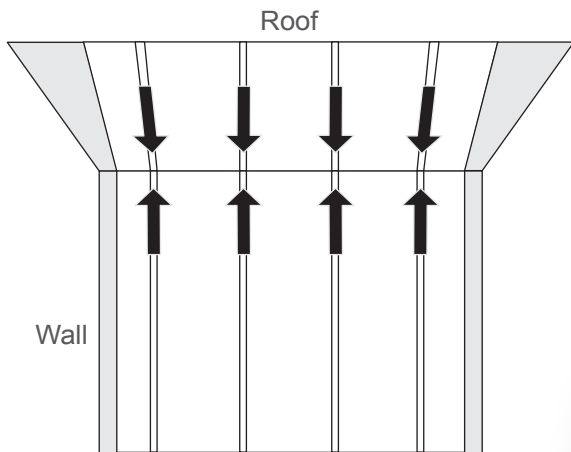

STEP 4. Install the Energy Saver fabric and banding (CONTINUED)

- 4.3** Working your way down from the top. Smooth the Energy Saver fabric out ensuring there are no wrinkles and install $\frac{3}{4}$ " tek screws with washers through the banding at each wall girt down to the base channel.

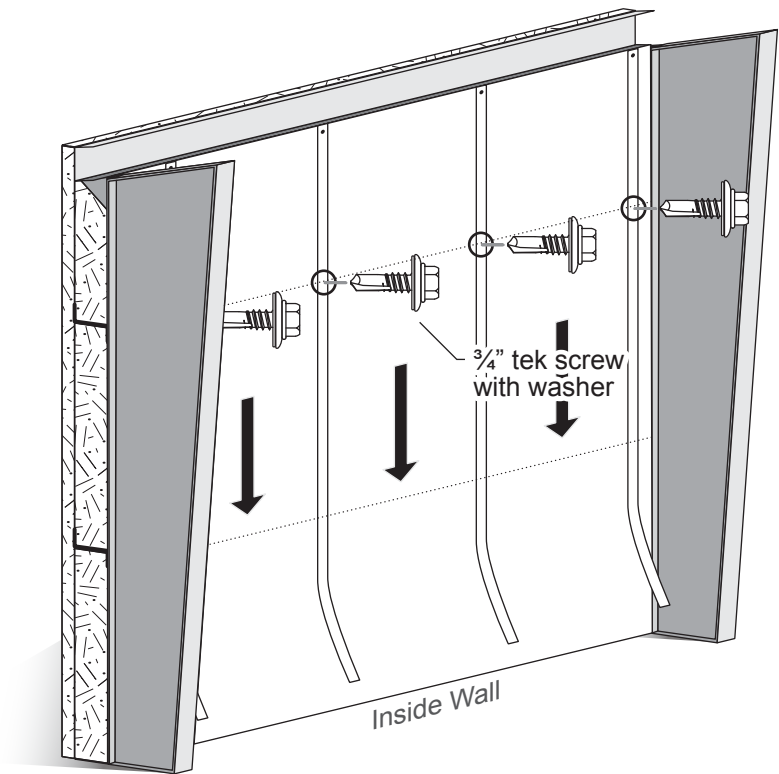

- 4.4** Gently pull the Energy Saver fabric back from the main structurals and remove the backing from the Energy Saver double sided tape. Apply the Energy Saver fabric to the tape. Press firmly to ensure the Energy Saver fabric adheres to the tape.

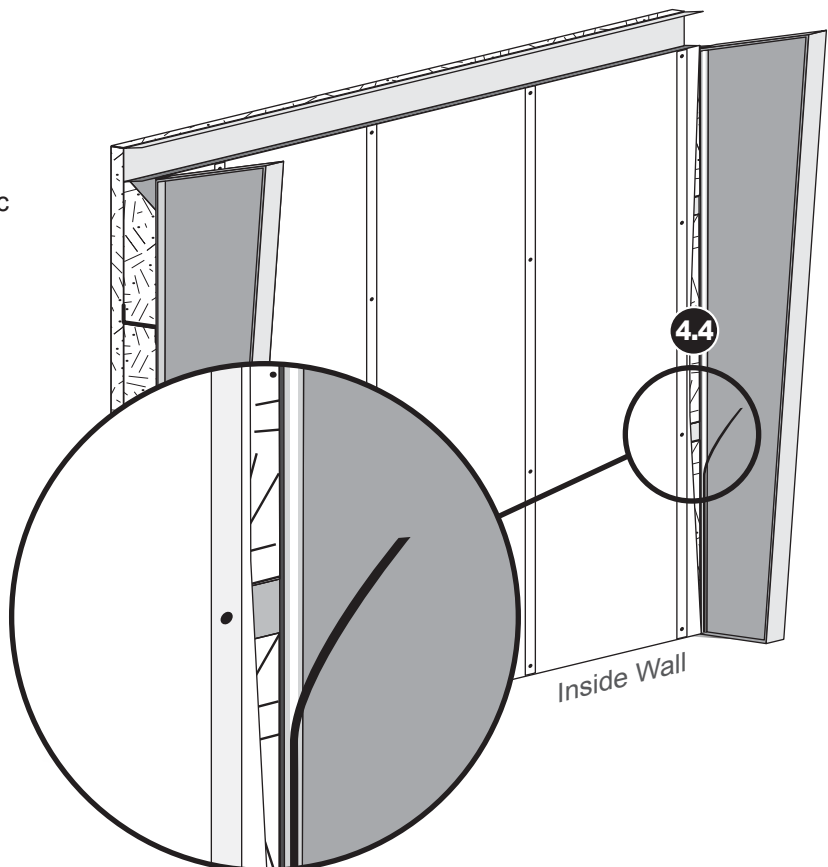

Endwall, Sidewall and Roof applications technical details

These can be downloaded from Silvercote.com or ask your Salesperson.

ENERGY SAVER WALL TO ENERGY SAVER ROOF CONNECTIONS

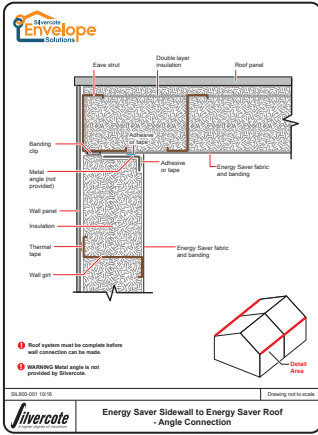

SIL800 - Energy Saver Sidewall to Energy Saver Roof - Angle Connection

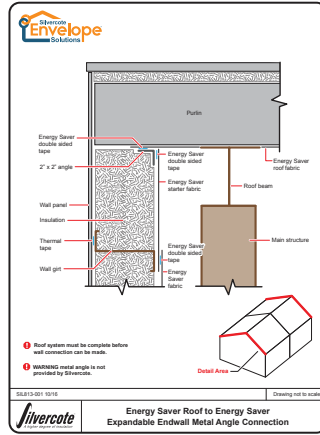

SIL813 - Energy Saver Expandable Endwall to Energy Saver Roof Connection

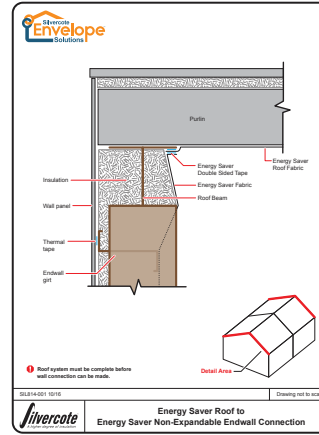

SIL814 - Energy Saver Non-Expandable Endwall to Energy Saver Roof Connection

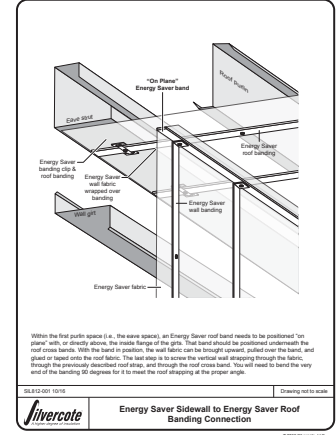

SIL812 - Energy Saver Sidewall to Energy Saver Roof - Banding Connection

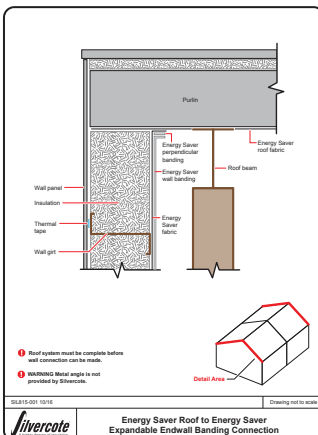

SIL815 - Energy Saver roof to Energy Saver Expandable Endwall Banding Connection

ENERGY SAVER WALL CONNECTIONS

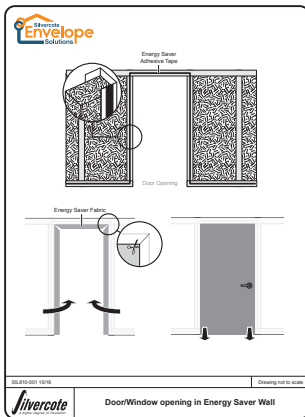

SIL810 - Energy Saver Door and Window Connection

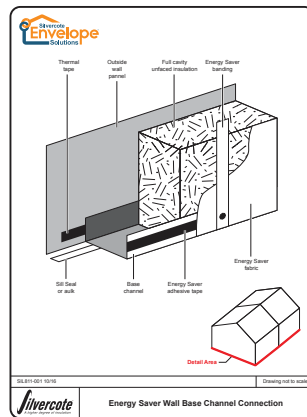

SIL811 - Energy Saver Wall Base Channel Connection

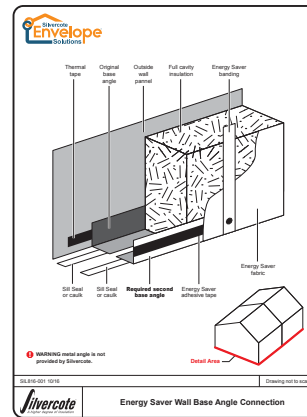

SIL816 - Energy Saver Wall Base Angle Connection

Endwall, Sidewall and Roof applications technical details (CONTINUED)

These can be downloaded from Silvercote.com or ask your Salesperson.

ENERGY SAVER WALL TO OTHER ROOF SYSTEMS

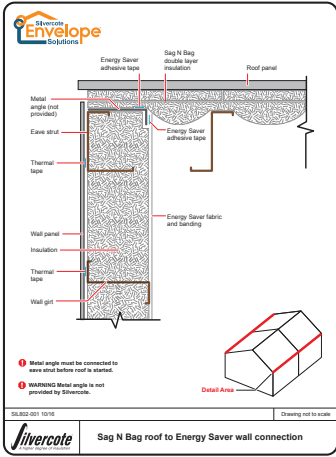

SIL802 - Sag N Bag Roof to Energy Saver Wall

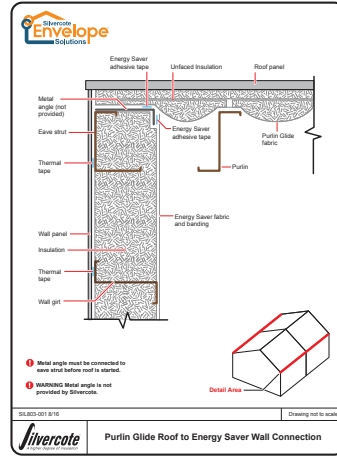

SIL803 - Purlin Glide Roof to Energy Saver Wall

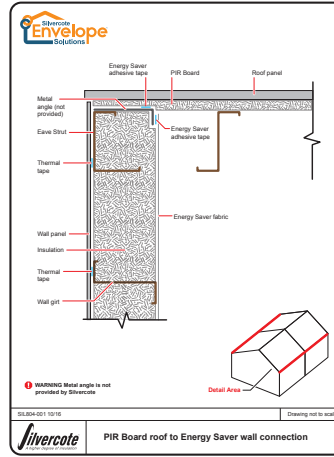

SIL804 - PIR Board Roof to Energy Saver Wall

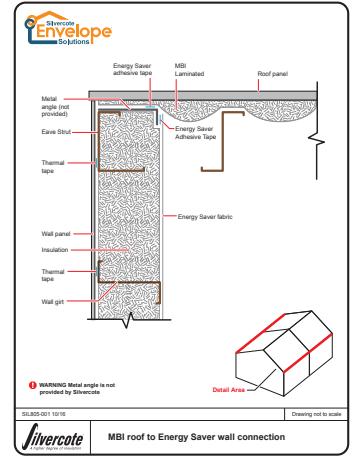

SIL805 - MBI Roof to Energy Saver Wall

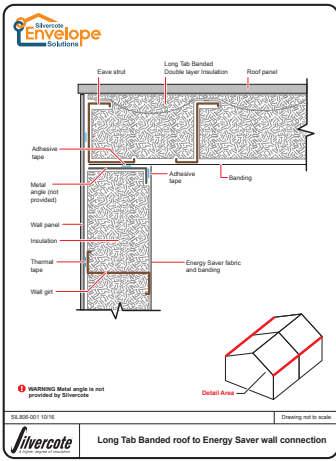

SIL806 - Long Tab Banded Roof to Energy Saver Wall